

CORI-FLOW®

Precision Mass Flow Meters / Controllers for Liquids and Gases



> Introduction

Bronkhorst High-Tech B.V., the European market leader in thermal Mass Flow Meters/Controllers and Electronic Pressure Controllers, has 25 years experience in designing and manufacturing precise and reliable measurement and control devices. With a wide range of instruments, Bronkhorst High-Tech offers innovative solutions for many different applications in many different markets. The instruments are made to customers' specification, in various styles, suitable for use in laboratory, industrial and hazardous areas, in such diverse applications as semiconductor and analytical installations, to name but two.

> CORI-FLOW® series direct mass flow meters and controllers

Bronkhorst High-Tech, specialists in low flow measurement and control, designed the CORI-FLOW® series mass flow metering instruments to provide high accuracy in three classes: $\pm 0,2\%$, $\pm 0,5\%$ or $\pm 1,0\%$ of Reading.

CORI-FLOW® utilises a patented, advanced Coriolis type mass flow sensor to achieve unsurpassed performance, even with changing operating conditions in pressure, temperature, density, conductivity and viscosity. The instruments are offered as separate flow meters or with close-coupled control valve or pump, thus constituting a compact Coriolis-type mass flow controller. The instruments have analog (0-5 Vdc / 4-20 mA) and RS232 output as standard and can, as options, be equipped with interface to Profibus-DP®, DeviceNet™, Modbus-RTU or FLOW-BUS.

There are 4 models with overlapping nominal flow ranges from 200 g/h up to 600 kg/h (full scale value), each offering "multi-range" functionality: factory calibrated ranges can be rescaled by the user, maintaining the original accuracy specs. Both meters and controllers are equipped with an IP65 weatherproof housing and are available with ATEX approval for use in Zone 2 hazardous areas.

> Fields of application

CORI-FLOW® instruments are applied in process fluid measurement or control systems in food, (petro-) chemical and pharmaceutical industries, in fermentation installations, in semiconductor processing and in fuel cell technology. Some typical examples of applications are described further on in this brochure.

> General CORI-FLOW® features

- ◆ direct mass flow measurement
- ◆ independent of fluid properties
- ◆ integrated PID controller for control valve or pump
- ◆ fast response time
- ◆ high accuracy, excellent repeatability
- ◆ compact, IP65 housing
- ◆ ATEX approval Cat.3, Zone 2
- ◆ option: bidirectional measurement

> Digital features

- ◆ DeviceNet™, PROFIBUS-DP®, Modbus-RTU or FLOW-BUS slave
- ◆ RS232 interface
- ◆ other fieldbus options on request
- ◆ alarm and (batch) counter functions



Bronkhorst®
HIGH-TECH

> Measuring principle

The CORI-FLOW® contains two parallel tube loops, forming part of an oscillating system. When a fluid flows through the tubes, Coriolis forces cause a variable phase shift between the loops, which is detected by sensors and fed into the integrally mounted pc-board. The resulting output signal is strictly proportional to the real mass flow rate.

NO FLOW

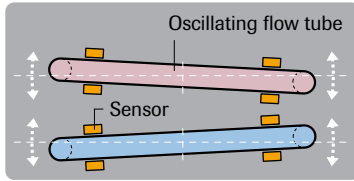

Differential sensing mode - top view

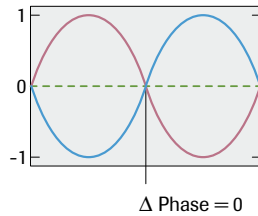

FLOW

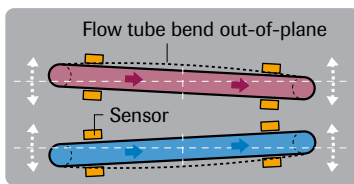

Differential sensing mode - top view

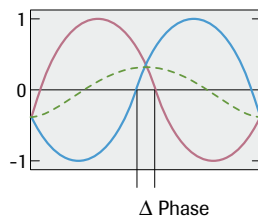

> Technical specifications

Performance flow sensor

Accuracy	Class A	: 0,2% of rate + zero stability, range 20:1
<i>Note: Class A</i>	Class B	: 0,5% of rate + zero stability, range 50:1
<i>for liquids only</i>	Class C	: 1,0% of rate + zero stability, range 100:1

Smallest Full Scale flow rates (values in kg/h)

	M52		M53		M54		M55	
	Gas	Liquid	Gas	Liquid	Gas	Liquid	Gas	Liquid
Class A min. FS rate	n.a.	1	n.a.	1	n.a.	10	n.a.	50
Class B min. FS rate	1	0,5	1	0,5	10	5	50	20
Class C min. FS rate	0,5	0,2	0,5	0,5	5	5	20	20
Recommended min. flow	0,02		0,05		0,2		0,5	
Zero stability	< 0,005		< 0,010		< 0,050		< 0,100	

Repeatability : 0,1% of rate
(based on digital output)

Mounting position : preferred mounting position on liquid service upside down

Operating limits flow controller

Control range	: 2...100%
(with elastomeric seat)	
Auto shut off	: valve closes when setpoint drops below 1,6%
Liquids and Gases	: any clean, homogeneous liquid or gas compatible with AISI 316 (or Hastelloy-C22 as an option)
Differential pressure	: recommended ΔP across control valve at least
mass flow controller	50% of total ΔP for liquids and 75% for gases
Settling time	: approx. 0,5 s

Mechanical

Process connections	: std. 1/4" face seal male, or 1/8", 1/4" or 6 mm OD compression type; other on request
Material of construction (wetted parts)	: stainless steel AISI 316 or equivalent; option for M52 / M53 / M54: Hastelloy-C22
Weight	: meter: approx. 3,1 kg meter + integral valve: 4,4 kg (max.)
Ingress protection	: IP 65 (weatherproof) for meter; for controller on request
Leak integrity	: < 2×10^{-9} mbar l.s ⁻¹ He
Pressure test	: 1,5 times max. stated operating pressure prevailing at customer
Max. operating pressure	: 100 bar
Temperature range (ambient + fluid)	: 0...70°C for standard version, 0...120°C with remote electronics, 130°C \leq 1 hour allowed for CIP

Electrical

Power supply	: +15...24 Vdc \pm 10%; (DeviceNet™ +24 Vdc only)
Consumption electronics	: approx. 80 mA at 15 Vdc
Consumption valve (if present)	: 250 mA (max) at 15 Vdc
Output signal	analog : 0...5 (10) Vdc; 2 kOhm min. load 0 (4)...20 mA (sourcing); 375 Ohm max. load
	digital : Profibus-DP®, DeviceNet™, FLOW-BUS, RS-232, Modbus
Command signal	analog : 0...5 (10) Vdc; 424 kOhm load 0 (4)...20 mA (sinking); 250 Ohm load
	digital : Profibus-DP®, DeviceNet™, FLOW-BUS, RS-232, Modbus
Electr. connection	: male, 8-pin Amphenol for power, analog I/O and RS-232
	option : standard M12 connector for Profibus (female) or DeviceNet™/FLOW-BUS (male)/Modbus (male)
CE approved design	



CORI-FLOW® Mass Flow Meter with pressure actuated control valve

> Flow capacity liquid

Basic model	DN (mm)	Nominal Flow*	Capacities (kg/h)														
			0,2	0,5	1,0	2,0	5,0	10	20	50	100	200	500	600			
M52	1	0,5 kg/h**	•	■	•												
M53	1	5 kg/h		•	•	•	■	•									
M54	2	50 kg/h				•	•	•	■	•							
M55	4	500 kg/h								•	•	•	•	■	•		

* Nominal flow: mass flow rate of liquid at a pressure drop of approx. 1 bar and based on reference conditions of water at approx. 20°C.

** Lowest recommended value for optimal performance is 20 g/h.

> Pressure drop liquid (H₂O)

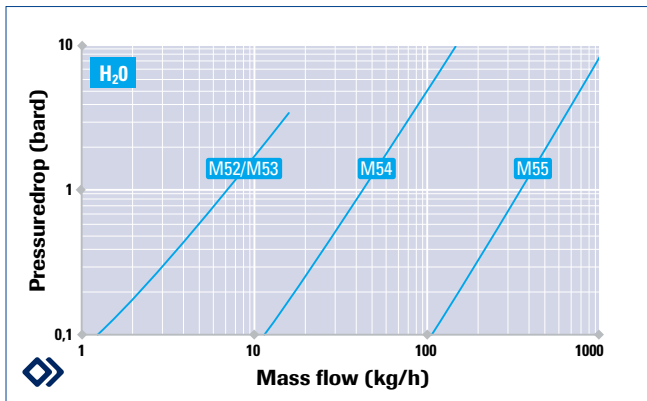

> Pressure P₁ vs. mass flow for Air (P₂ = 1 bara)

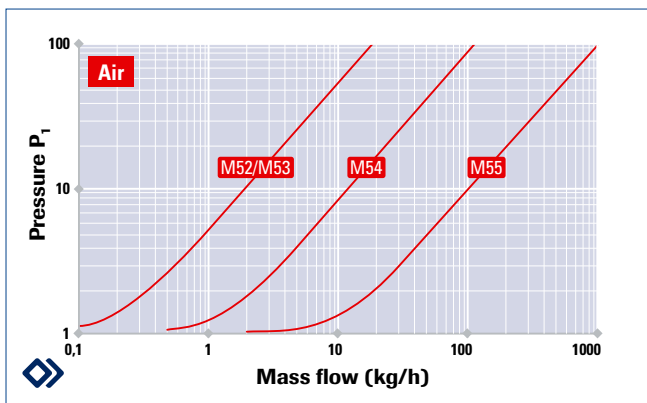

* Capacity based on air flow measurement: capacity shown increases with pressure; max. allowable pressure is 100 bara.

> Table 1 (Z-values in mm)

Connections (in/out)	M50	M50C2/ M50C5I	M50C4
1/8" compression type	201	267	-
1/8" face seal male	194	260	-
1/4" compression type	204	270	306
1/4" face seal male	202	267	301
1/4" face seal female	202	267	-
6 mm compression type	204	270	306

Dimensions (mm)

M50-Series Mass Flow Meter

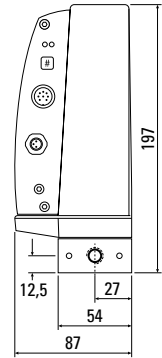
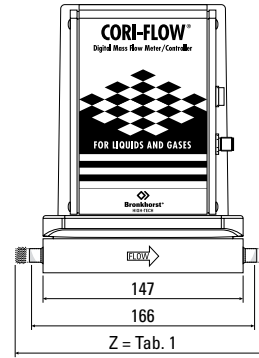

M50C2-Series Mass Flow Meter Controller

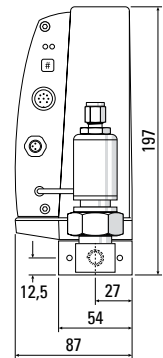
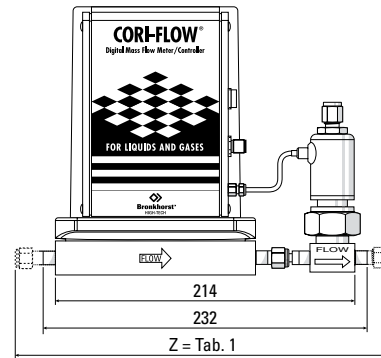

M50C4-Series Mass Flow Controller

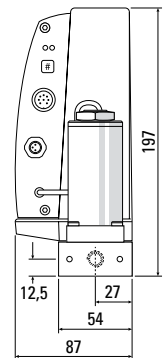
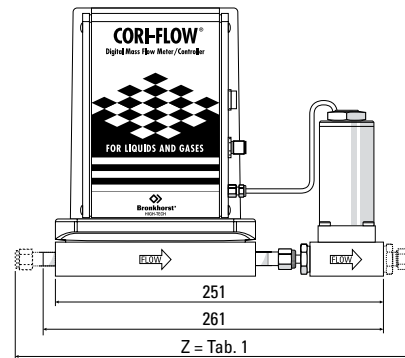

M50C5I-Series Mass Flow Controller

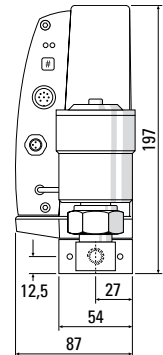
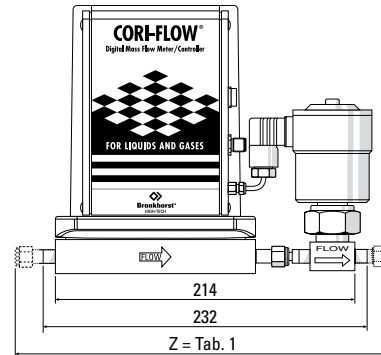

Technical specifications and dimensions subject to change without notice.
Dimensional drawings for other MFCs available on request.

> Applications

The CORI-FLOW® is suitable for application in industrial environment, laboratories and OEM installations in the following markets (typically):

- ◆ Surface treatment,
- ◆ Energy (fuel cells),
- ◆ Semiconductor industry,
- ◆ Chemical industry,
- ◆ Pharmaceutical industry,
- ◆ Food industry,
- ◆ Optical fibre industry, etc.

> CORI-FLOW® Application

Critical gas measurement

Fluids like carbon dioxide (CO₂) and ethylene (C₂H₄) are difficult to measure when they are in the interphase stage between being a liquid and a gas. This occurs at temperatures >20°C when pressure ranges from approx. 20 bara to approx. 60...95 bara (depending on temperature).

Under these conditions, physical properties like density (ρ) and heat capacity (C_p) change very rapidly which makes an accurate mass flow measurement, based on the thermal principle, very difficult.

CORI-FLOW® offers a solution here because of the true mass flow measurement, **independent of physical properties**. The **true** mass flow of the molecules is measured, regardless of whether the fluid is in gas phase, in liquid phase or indeed somewhere in between. Experiences in the field have proven that this principle of measuring is very accurate and reliable.

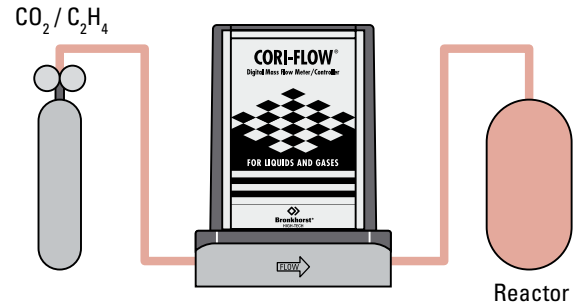

> CORI-FLOW® Application

CORI-FLOW® with pump control, Profibus-DP operated

By utilising the integrated PID-control function on the CORI-FLOW® meter, a desired mass flow can be controlled with either a traditional proportional valve or now, more commonly, with a pump as the actuator. The PID-control to the pump can either be via a direct analogue signal (0...10 V, 0...15 V, 0...20 mA, 4...20 mA) or can be via a voltage/current to frequency converter if this feature is available. The maximum power load for the PID-controller output is ~3.75 Watt. PID-settings for optimal pump control can be set using FlowPlot, a Bronkhorst tooling program. Most commonly this will be performed in the factory, however, in line with the Bronkhorst Total Service Concept it is also possible to do this on site.

CORI-FLOW® instruments can be operated using normal analog signals or via digital interfaces such as RS-232 or fieldbus communication. Profibus-DP is popular within the process industry as it offers a straight forward connection between a master, a PC or PLC (e.g. Siemens S7-300/400) and its slave devices. Within such a system, the CORI-FLOW® instrument would act as one of the slave devices and as such would have its control behaviour influenced by the master device. This offers high flexibility in mass flow control.

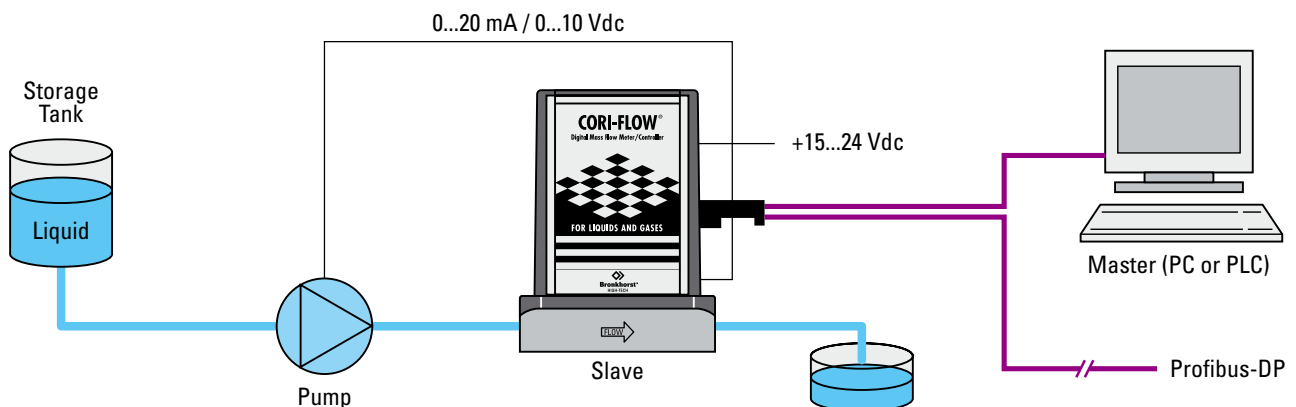

> CORI-FLOW® Application

Batch control

Bronkhorst CORI-FLOW® instruments include an integrated counter for totalisation of preferred mass units, e.g. grams or kilograms. The counter can be programmed for continuous increase or for totalisation up to a pre-set limit. Upon reaching this limit, several further actions can be programmed; for example, an alarm signal and/or a change of setpoint to the integrated controller. By utilising the integrated counter function, a CORI-FLOW® instrument is able to totalize the measured mass flow extremely accurately. The full program cycle is very fast (< 50 msec) so the true flow will be integrated in almost real-time. The user-set counter and counter limit can then be employed for exact dosing of the desired batch.

First a setpoint will be provided to the integrated PID-controller connected to a proportional valve or to a pump. Upon reaching the limit/batch total, the instrument can close the valve or stop the pump by generating a setpoint of 0% for the controller.

Simultaneously, an alarm can be given to the external computer or simply signal to LED's. Following a reset command (manual or remote) the next batch can commence.

By using these integrated facilities a very stable, accurate and compact dosing solution is provided.

Example:

A vial needs to be filled repeatedly with 375 grams of water in 30 seconds. Correct sizing ensures that the equivalent flow rate of 45 kg/h can be fulfilled by our M54C5I model. If the outlet pressure (P2) is atmospheric (1 bara) the minimum inlet pressure (P1) should be ≥ 3 bara. The pressure drop over the sensor will be approx. 1 bard and we recommend an equal value across the valve. The orifice needed will be 1.7 mm. Batch control will be performed using the FlowView application programme (Freeware) connected to the instrument via Flow-DDE and RS-232 interface.

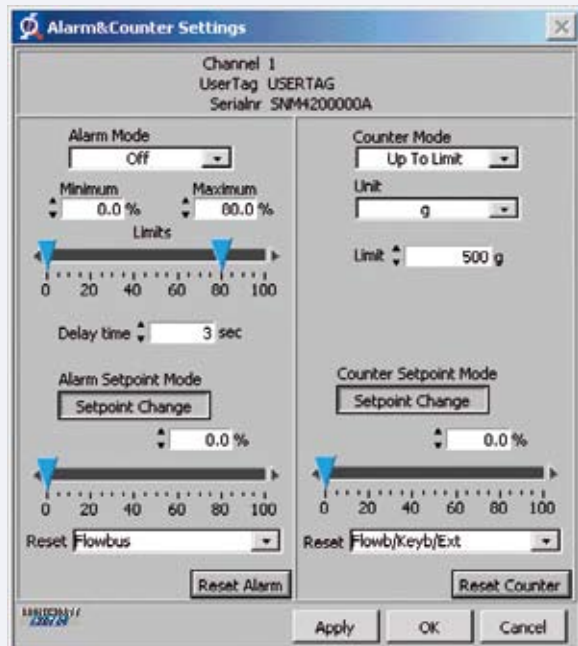
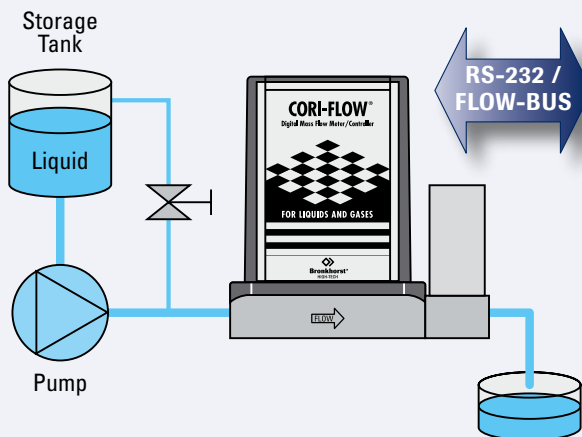

> Model number identification

M5N - AN(I) - AAA - NN - A - A

Mass flow meter

M52	Nominal range	500 g/h
M53	Nominal range	5 kg/h
M54	Nominal range	50 kg/h
M55	Nominal range	500 kg/h

Control valve

C0 (I)	Low Flow control valve (nc) PN100	gas; Kv-max = $6,6 \times 10^{-2}$
C1 (I)	Low Flow control valve (no) PN100	gas; Kv-max = $6,6 \times 10^{-2}$
C2 (I)	Low Flow control valve + purge connection (nc) PN100	liquid; Kv-max = $2,3 \times 10^{-3}$
C3 (I)	Low Flow control valve + purge connection (no) PN100	liquid; Kv-max = $2,3 \times 10^{-3}$
C4 (I)	Medium Flow control valve (nc) PN10	gas or liquid; Kv-max = $3,0 \times 10^{-1}$
C5I	Medium Flow control valve (nc) PN100, IP65	gas or liquid; Kv-max = $6,6 \times 10^{-2}$

add 'I' for IP65 coil on control valve

PC-board

A	with RS-232 and analog I/O	(nc) controller-function
B	with RS-232 and analog I/O	(no) controller-function
D	with RS-232 and DeviceNet I/O	(nc) controller-function
E	with RS-232 and DeviceNet I/O	(no) controller-function
M	with RS-232 and Modbus I/O	(nc) controller-function
N	with RS-232 and Modbus I/O	(no) controller-function
P	with RS-232 and Profibus I/O	(nc) controller-function
Q	with RS-232 and Profibus I/O	(no) controller-function
R	with RS-232 and FLOW-BUS I/O	(nc) controller-function
S	with RS-232 and FLOW-BUS I/O	(no) controller-function

Output

A	0...5 V
B	0...10 V
F	0...20 mA sourcing
G	4...20 mA sourcing

Supply voltage

B	+ 24 Vdc (DeviceNet)
D	+ 15...24 Vdc (analog, FLOW-BUS, Profibus, Modbus)

Connections (in/out)

1	1/8"	OD compression type
2	1/4"	OD compression type
3	6 mm	OD compression type
4	12 mm	OD compression type
5	1/2"	OD compression type
7	1/4"	Face seal female
8	1/4"	Face seal male
9	Other	

Internal seals

0	None (sensors)
V	Viton (valves for gas)
E	EPDM
K	Kalrez-6375

Accuracy class

A	0,2% Rd. + 0-stability
B	0,5% Rd. + 0-stability
C	1,0% Rd. + 0-stability



M50C5I series Mass Flow Controllers



CORI-FLOW® Mass Flow Meter
with dosing pump and filter

Bronkhorst
HIGH-TECH

Nijverheidsstraat 1a, NL-7261 AK Ruurlo The Netherlands
T +31(0)573 45 88 00 F +31(0)573 45 88 08 I www.bronkhorst.com E info@bronkhorst.com

